

MESSAGE OF SHAPE

for the interior full of life





The interaction

between built spaces and human beings is in the focus of the architectural draft.

Its design language
**decisively affects
our sensation in the room.**

It can make us feel comfortable or rather uneasy.

Functional elements

not only complement the atmosphere of the room.

*They give it its unique **identity** thus making it so **valuable**.*



To obtain holistic interior design, plenty of different factors, such as light and room climate, shall be equally considered. The harmony created this way positively affects the human organism – both physiologically and psychologically.

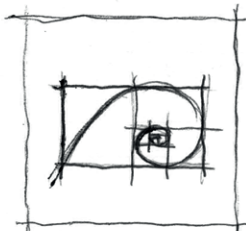

Proportion

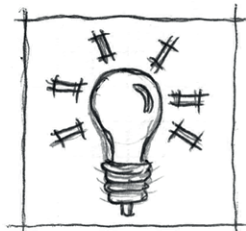

Light

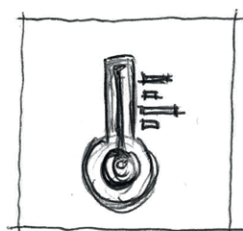

Climate



Acoustics



Colour

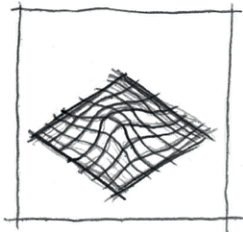

Surface



Health

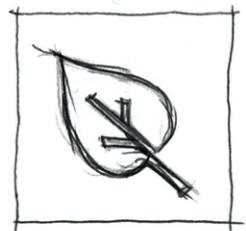

Environmental
compatibility

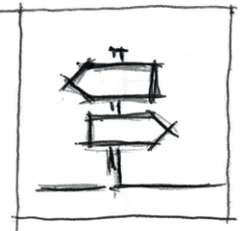

Orientation



And since every object, every room is unique, our individual

moulded components

customised to your concepts are best suited to perfect the intended overall appearance.

Projects from

2D drafting to detailed 3D modelling



We offer you ready-to-use components and tailored solutions for your vision and your design. Your freedom of creativity is almost unlimited. Simple geometric or complex three-dimensional shapes – you will obtain custom-fit individual modules for the integration into your ceiling system. The high degree of pre-fabrication allows for faster installation and preserves the quality of the end result. At the same time, we always adapt our structures made of gypsum plasterboard or fibre-reinforced gypsum to your budget and your requirements.

Your benefits:

- Holistic assistance
- Customised solutions for your planning
- Advice and support in all project phases
- Optimal lighting effect and flexible design
- Time efficiency in assembly and installation

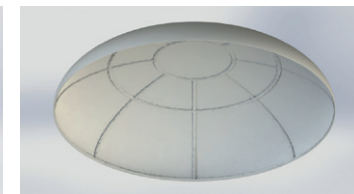
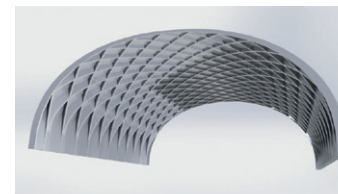



Value retention

From drafting to implementation

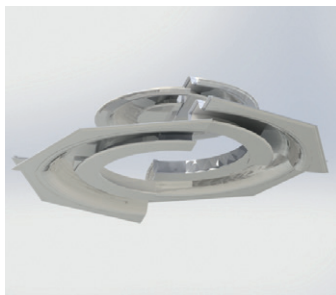

Perspective view from above – installation sequence of individual elements

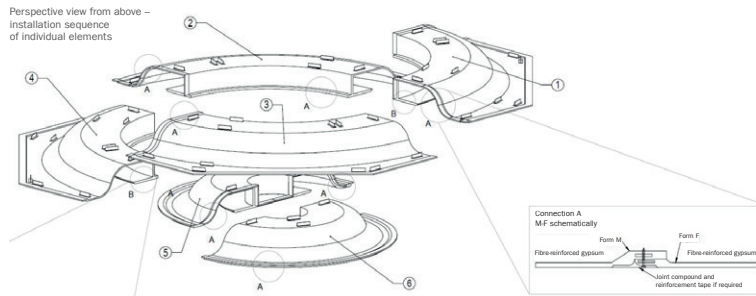

To obtain an ideal illumination solution, we will design a suitable moulded component together with you. Depending on the requirement, we can opt for gypsum plasterboard or fibre-reinforced gypsum. This will allow us to realise a virtually unlimited variety of shapes.

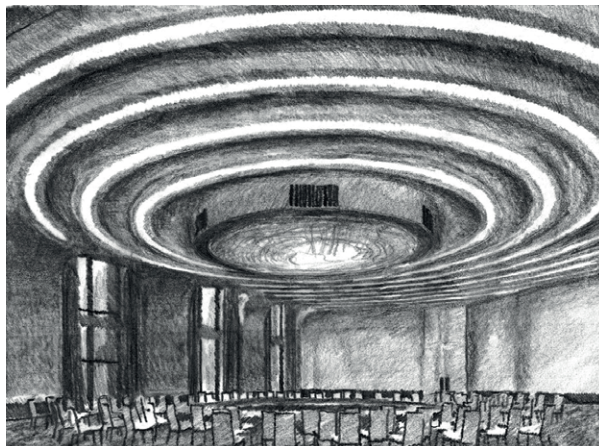

Yet in doing so, it is of utmost importance to us, to offer you the greatest possible certainty in terms of planning and expenditure. To achieve this, we set great store by detailed elaboration and practicability. Due to a high degree of pre-fabrication of our components coupled with the construction site-specific delivery, we create the perfect prerequisite for your project.

Various designs at a glance

Edges by means of

individual components

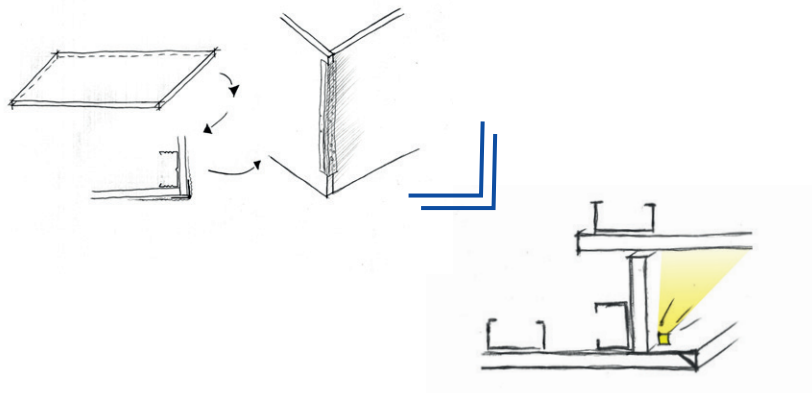

pre-fabricated V-cuts

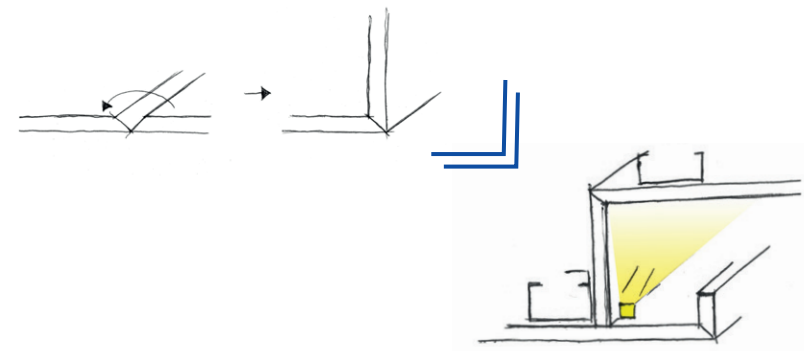

By using pre-fabricated grooves, you ensure qualitative value retention already during installation. Since only custom-fit panels rather than a great many of individual components are used during on-site installation. The cardboard-clad and smooth visible edge forms an optimal surface and exact edge design to achieve precise lines in the room concept.

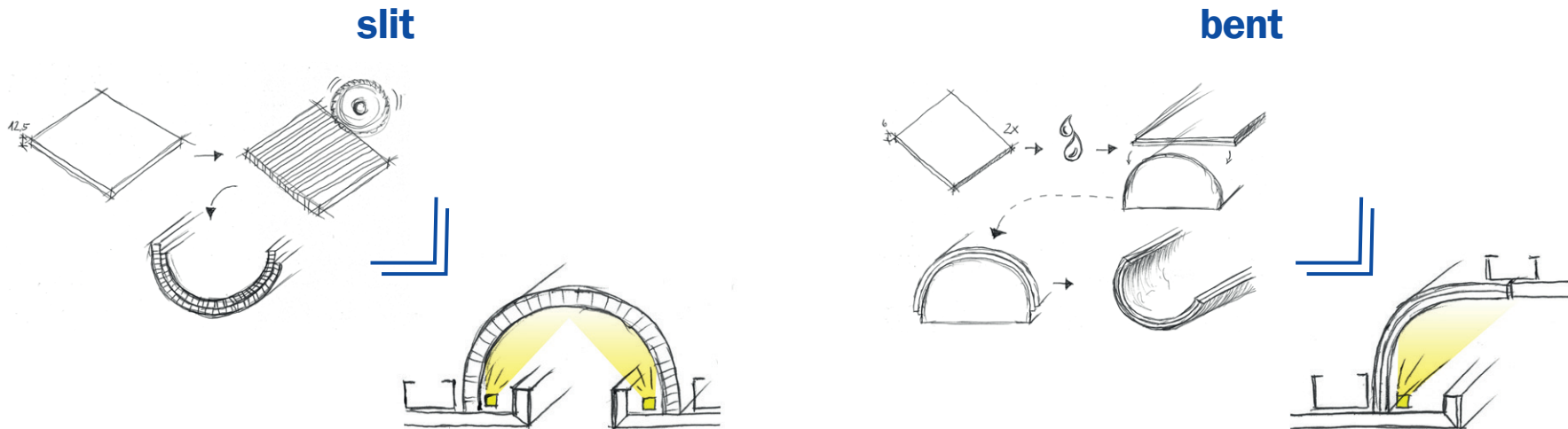

Depending on the requirement and geometry, the half shells or ceiling segments are made from either slit or curved plasterboard panels. The selection of the suitable material depends on the desired surface quality, the dimensions of the moulded component and, of course, the budget.

Various designs at a glance

3D free shapes made of

fibres-reinforced gypsum

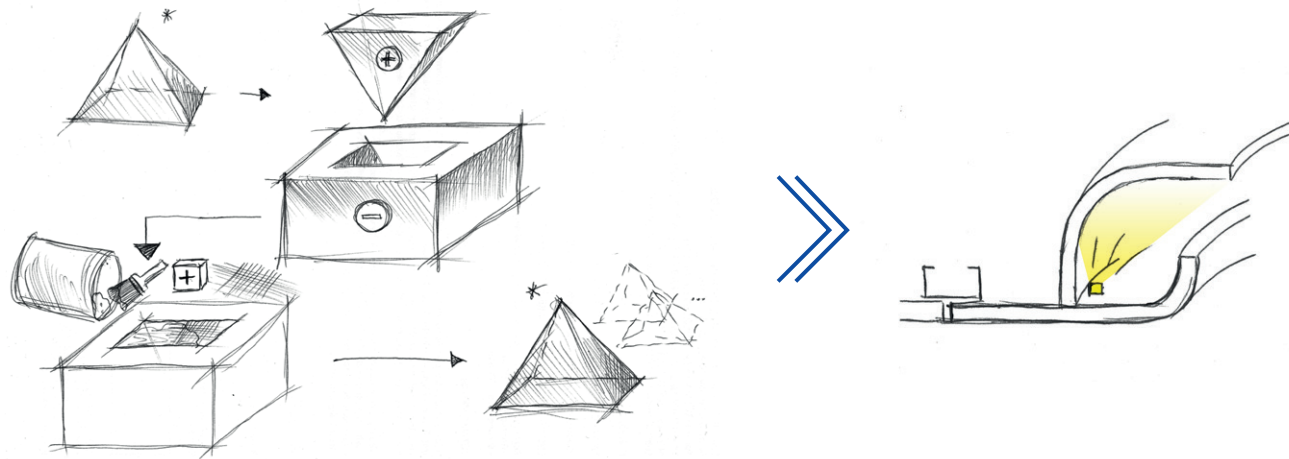

Fibre-reinforced gypsum is particularly suited for sophisticated designs and complex geometric shapes (be it two- or three-dimensional). Even organic structures can be implemented with its help.

Moulded components made of fibre-reinforced gypsum are produced from a negative form by means of a lamination process. If a project includes recurrent shapes, radii or the like, this method is particularly economical.

EXAMPLE – integral ceiling element

Funnel, integrated spot

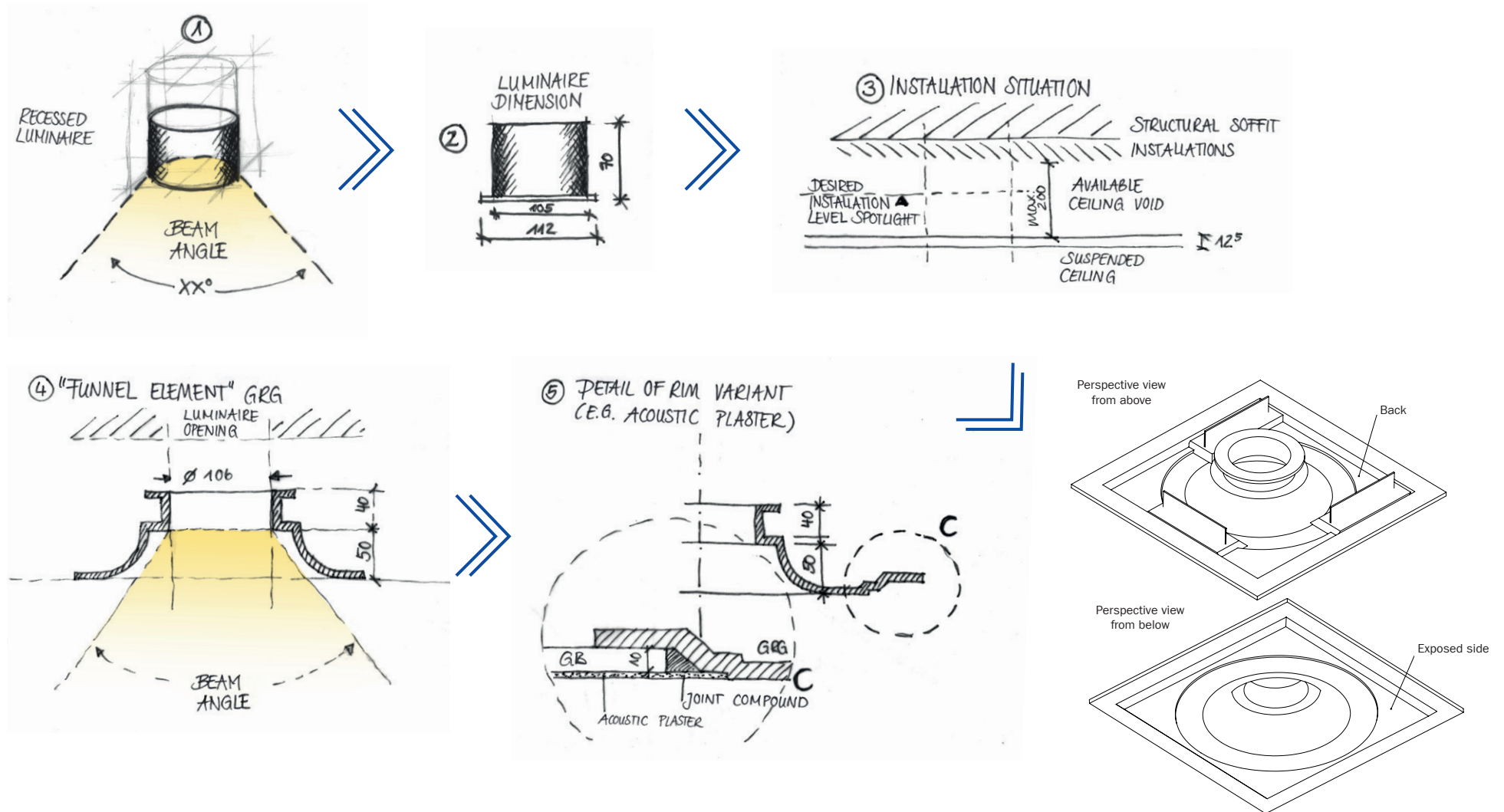

EXAMPLE – integral ceiling element

Circular covered lighting

① LIGHTING DESIGN /
IDEA 2D CIRCULAR COVERED LIGHTING

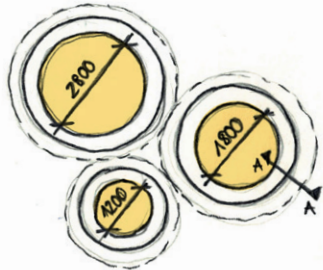

② COVERED LIGHTING
CROSS-SECTION

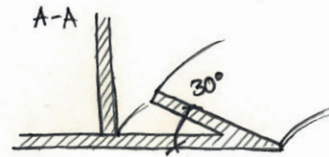

③ SHARP-EDGED
DESIGN?

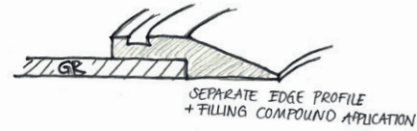

④ REFLECTOR INTEGRATION

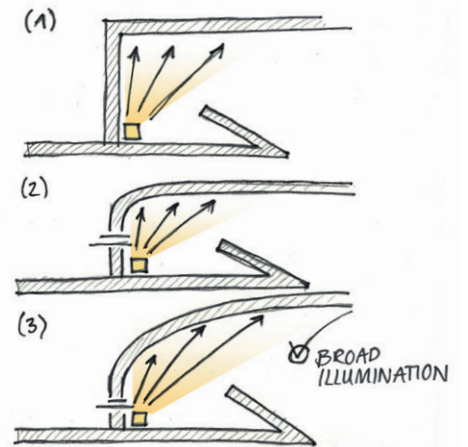

⑤ GRG POSSIBILITIES

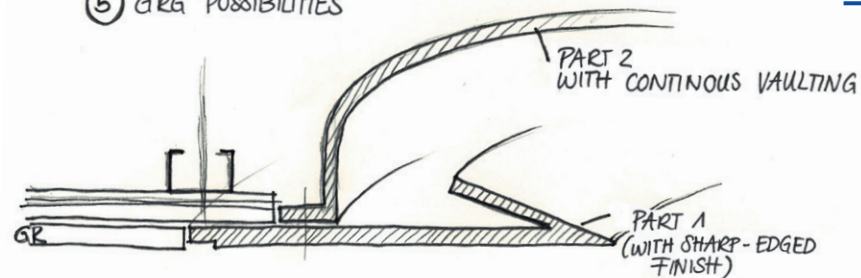



EXAMPLE – integral ceiling element

Made of fibre-reinforced gypsum

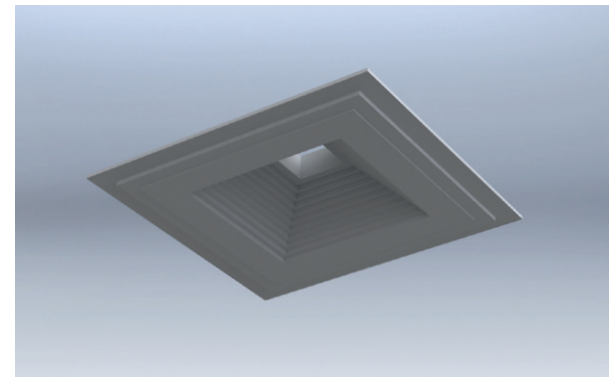
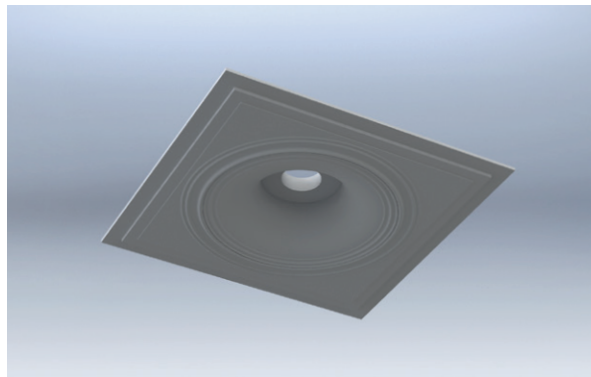
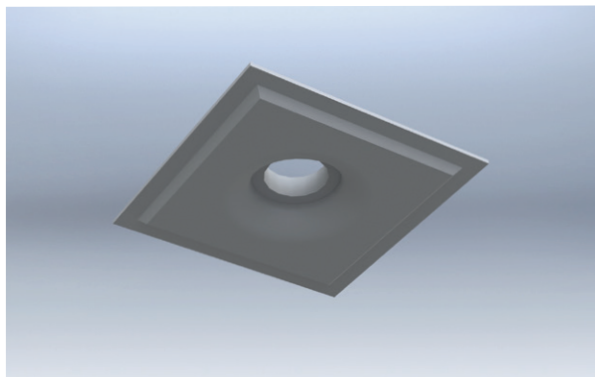
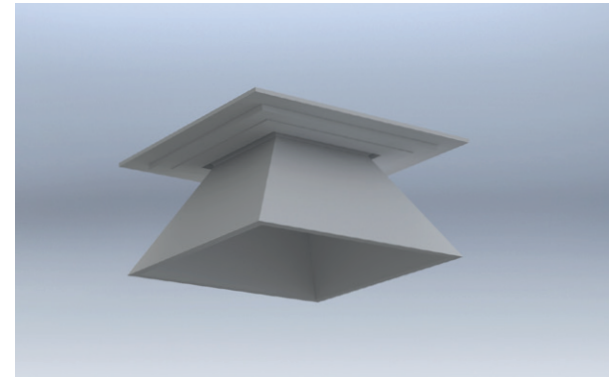
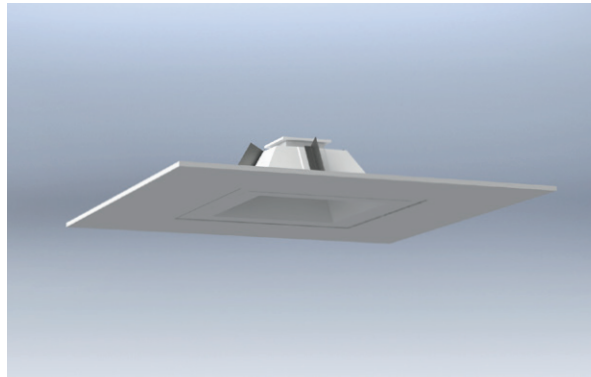
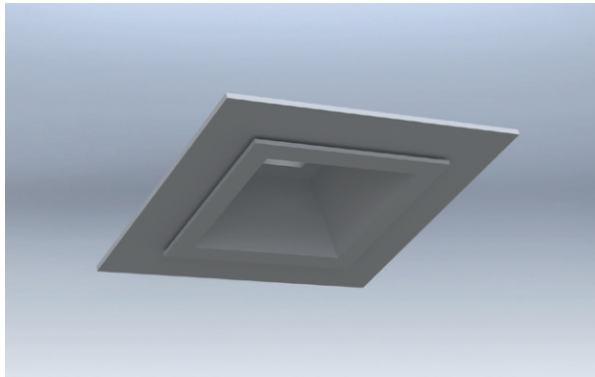

Project: Baader Food Processing Machinery
Product: fibre-reinforced gypsum



Project: State Parliament of Lower Saxony
3D design product: moulded gypsum plasterboard components



Project: prizeotel hotel
3D design product: moulded gypsum plasterboard components



Project: BKK Wiener Linien health insurance
3D design product: moulded gypsum plasterboard components

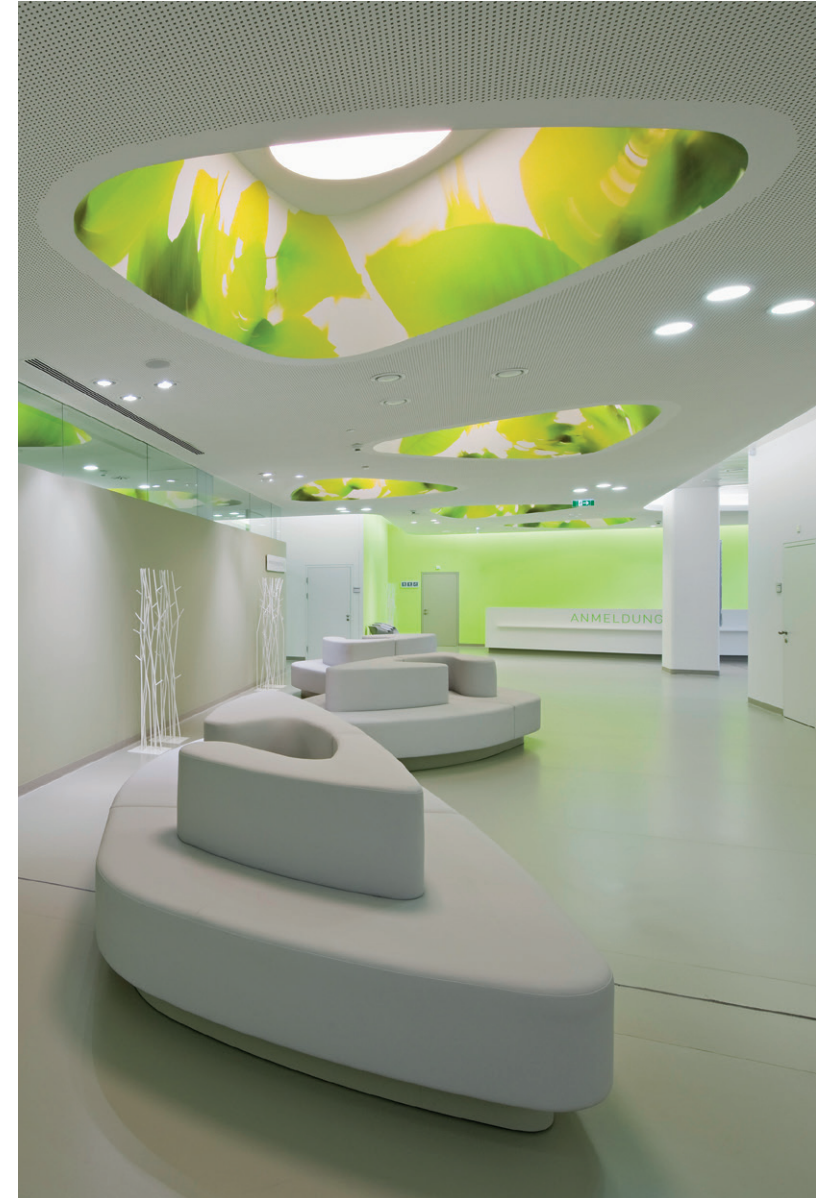

Project: The Kunsthalle Bremen art gallery
Illuminated ceiling product: Rentex illuminated stretch ceiling



Project: Lago Shopping Centre in Konstanz
Product: fibre-reinforced gypsum



ORB. Atelier für Lichtgestaltung

Project: Shannon Airport
3D design product: moulded gypsum plasterboard components



Project: staff restaurant “franz” at F. LIST GMBH in Thomasberg
Product: Toptec acoustic plaster system



Project: Dallmayr Lukkulus Bar in Munich
3D design product: moulded gypsum plasterboard components



Be it linear or
Surface illumination

spot illumination



Following your technical requirements (e.g. beam angle, ceiling void), we manufacture moulded components and housings for spot illumination.

linear illumination (direct / indirect)

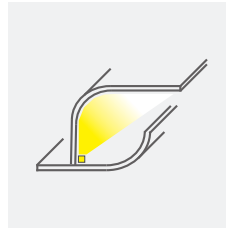

Be it light channel structures or linear moulded components for lighting integration – we will work out the optimal solution for your lighting design in close coordination with you.

surface illumination (illuminated ceilings)

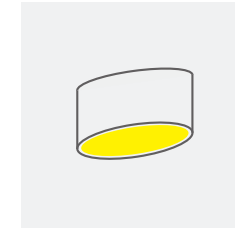

With the help of our system partner Rentex, we will adjust our moulded components to your desired illuminated or stretch ceiling down to the tiniest detail.



Your contact partners

Markus Ranzinger
Sales Manager Export

Mobile: +49 174 3200343
ranzinger@vogl-deckensysteme.de

Stefanie Kolb
Interior Architect, MA

Phone: +49 9104 825-237
kolb.s@vogl-deckensysteme.de

Vogl Deckensysteme GmbH

Anton Vogl Str. 1
91448 Emskirchen/Germany

Phone: +49 9104 825-0
Fax: +49 9104 825-250

info@vogl-deckensysteme.de
www.vogl-deckensysteme.de

PICTURE CREDITS

Pages 1 and 2: Svenja Bockhop, Berlin - Page 5: Zooey Braun - Pages 10 and 12: Michael Bogumil - Page 13: Tom Figiel - Page 14: Torsten Elger - Page 15: Hertha Humaus / Architecture: lakonis Architekten, Vienna - Page 16: Stefan Müller - Page 17: Armin Kuprian, ORB. Lighting design studio - Page 18: Julia Dumin - Page 19: Clemens Schneider - Page 22: Franz Brück

Status 09/2020